

| | | | | | | | |
|------|-----------------|-----------|-----|-------|----------|---|---|
| 1 | 2 | 3 | 4 | 5 | 6 | 7 | 8 |
| ITEM | PART NO | PART NAME | QTY | COLOR | ART WORK | | |
| 1 | GT32S06-E(G3V3) | BLACK | 1 | NA | | | |

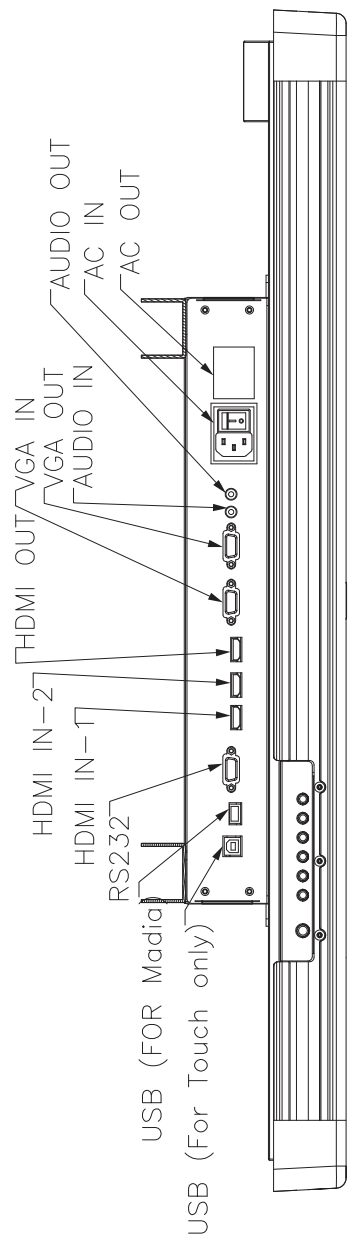

SECTION: C-C
SCALE: 0.200

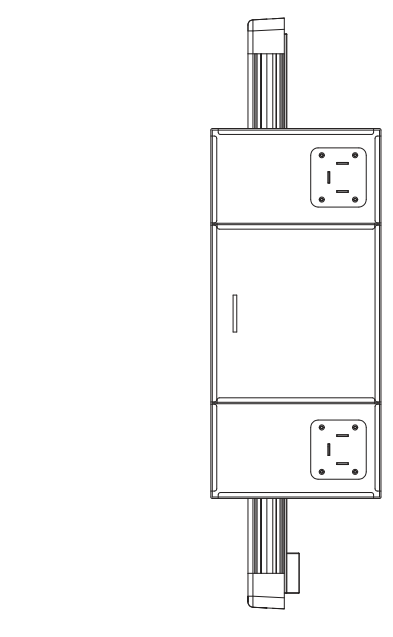
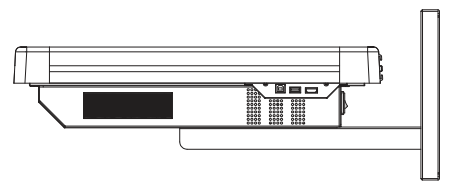
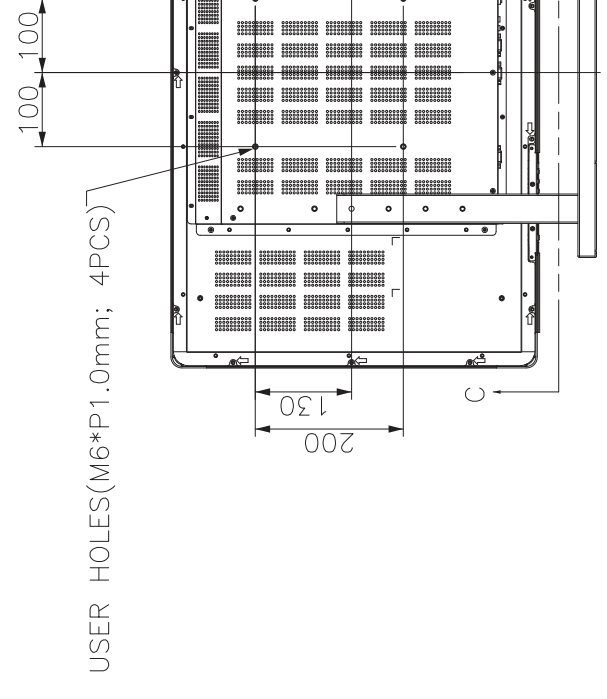
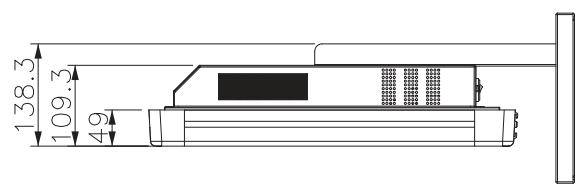
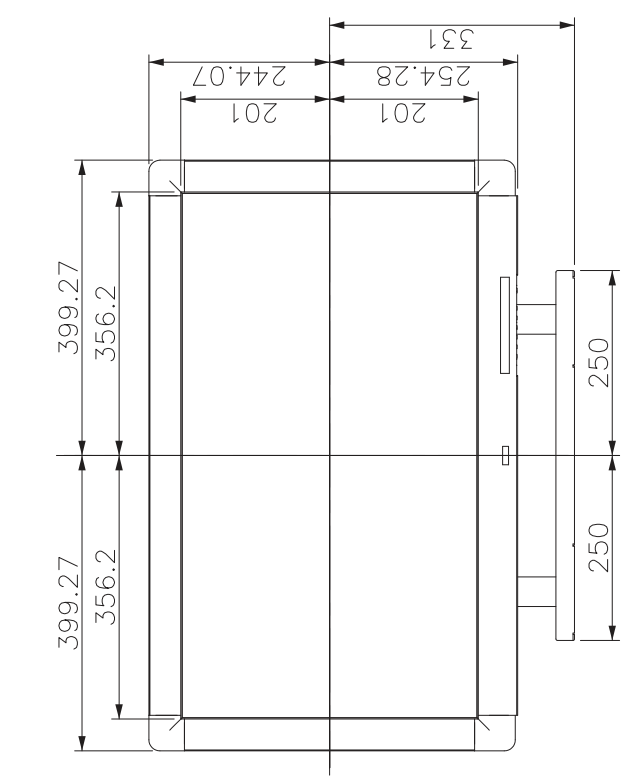
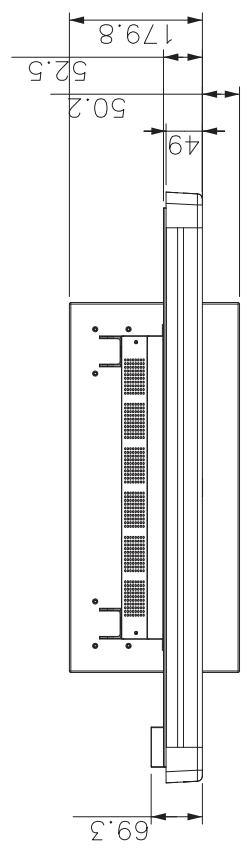

| REFERENCE TOLERANCE | |
|---------------------|-------|
| RANGE | TOL.± |
| 0.5~3 | ±0.05 |
| 3~6 | ±0.05 |
| 6~30 | ±0.1 |
| 30~120 | ±0.15 |
| 120~400 | ±0.2 |
| 400~1000 | ±0.3 |
| 1000~2000 | ±0.5 |
| 2000~4000 | - |
| ANGLE | ±1° |

| ITEM | Rev. | DESCRIPTION | DATE | SIGN | REMARK |
|-------|-----------------|-------------|-----------------|------|-------------|
| MODEL | GT32S06-E(G3V3) | NAME | GT32S06-E(G3V3) | A0 | 07-Apr-14 |
| DRN | Julia Huang | MATERIAL | METAL | REV | DESCRIPTION |
| DSN | | FINISH | PAINTING | | DATE |
| CKD | | | | | DIM IN |
| APPD | | | | | Scale |
| | | | | | mm |
| | | | | | SHEET |
| | | | | | 1 |
| | | | | | OF |
| | | | | | 1 |
| | | | | | DRAWING NO |
| | | | | | 8 |